

000262

50.02
03-98

- Ripple Fin[®] tubing
- Eurovent certified
- Selektion based on DT₁
- Capacities for R 22, R 134a and R 404A



Blow Through **Unit Coolers**

LEX

New air cooler generation with better performance

Capacities 1.5 - 40 kW

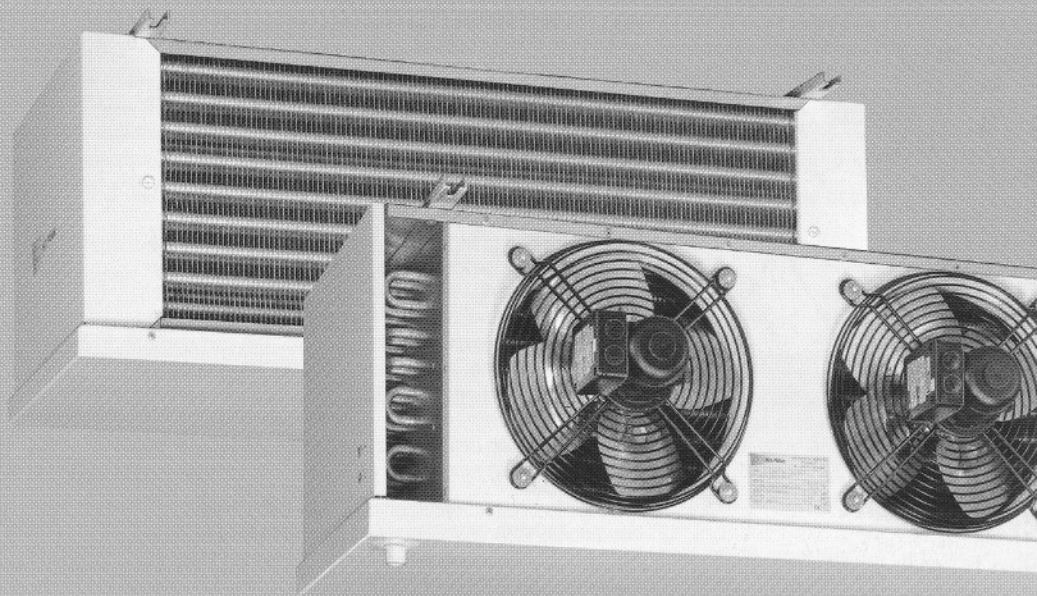

HELPMAN

participant of the
EUROVENT
certification programme

Blow Through Unit Coolers 1.5 - 40 kW**LEX****Eurovent**

Within Europe, a wide variety of published data on capacities are in use, generally depending on national standards.

Most in use by the leading manufacturers are national and international standards like DIN, ENV, NEN and ASHRAE.

Due to this, customers have not been able to make objective product comparisons, since data published on capacities were based on DT₁, DTM, dry or wet conditions, with or without certification, etc.

To meet the European requirements on EN standards, the European Refrigeration Industry embodied by Eurovent has set standards to guarantee an independent certification procedure for forced convection air cooled condensers based on ENV 327 and unit air coolers based on ENV 328. Being an active member of Eurovent, the capacities of the Helpman commercial cooler programme, as given in the technical documentation, are based on ENV 328.

(Evaporating temperature $t_e = -8\text{ }^\circ\text{C}$,
8 K temperature difference between air-on temperature and evaporating temperature DT₁.)

In order to enable aircooler selection for operating conditions, technical documentation should also give capacities for humid/frosted conditions. According to Eurovent these 'frosted conditions' are to be calculated by multiplying 'dry capacities' with a factor 1.15. These data can be found in the capacity tables, in the columns "frosted conditions".

CE Marking

All coolers and condensers produced by Helpman comply with the EC Machinery Directive 89/392. In this respect all equipment is provided with extensive product information and a 2B Certificate.

CE-marking of complete cooling installations is obligatory as per 1 January 1995. The CE-marking support of Helpman cooling components therefore offers full service to refrigeration installers to meet the requirements on CE marking of cooling installations.

DT₁**Selection Example DT₁**

Selected cooler model	LEX
Selected fin spacing	7 mm
Required cooling capacity	6.8 kW
Air-on temperature	-16 °C
Evaporating temperature	-25 °C
Refrigerant	R 22

The calculation is based on the tables on page 4.

- 1) $DT_1 = -16 - (-25) = 9\text{ K}$
- 2) Correction factor (table) : 1.09
- 3) Multiply required capacity with correction factor :
 $6.8\text{ kW} \times 1.09 = 7.4\text{ kW}$.
- 4) A cooler has to be selected in column R 22, frosted DT₁, with a nominal capacity of 7.4 kW.

For the above mentioned conditions a LEX 16 - 7 unit cooler with nominal capacity of 7.4 kW can be selected.

Blow Through Unit Coolers 1.5 - 40 kW

LEX



General

The LEX range of general purpose unit coolers consists of 30 basic models.
 Fin spacings 4 or 7 mm with 1 to 4 fans, blowing through the coil.
 Temperature application area + 5 °C to -35 °C.
 Capacity range 1.5 up to 40 kW.
 Suitable for all halocarbon refrigerants including R 22, R 134a and R 404A for use in cooling and freezing rooms.
 For general purpose coolers in draw through design see LZX. For air sock application see LXA.

Type Indication

LEX 14 - 7 E / C - 220

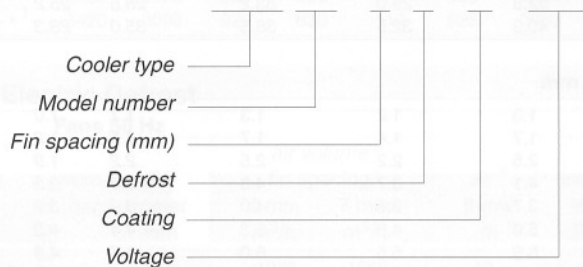

Features

- Coil : copper Ripple Fin® tubing with aluminium fins. Fin thickness 0.35 mm. Tube diameter 1/2", tube wall thickness 0.40 mm. Tube centres 38 x 38 mm square pitch. Coils are pressure tested with dry air at 25 bar.
- Blow through design. Coil is air straightener; less turbulent air flow.
- Eflo® refrigerant circuiting for higher effective cooling capacity.
- Durable aluminium casing, white epoxy coated, RAL 9003. Other colours on request.
- Models up to LEX 12 fitted with hinged interchangeable side plates for easy access, LEX 14 and up with easy removable side plates.
- All models equipped with splash guard.
- Available with electric defrost in coil and driptray, or hot gas coil in driptray.
- Equipped with a Schrader valve on the suction connection for testing purposes.
- Sufficient room for fitting the expansion valve inside.
- Stickers indicate fan direction and refrigerant in/out.
- Heavy duty packing in boxes or crates. LEX 18 and up delivered on wooden beams in mounting position.
- All models available on request for pumped circulation and glycol.

Two Year Full Guarantee

Helpman only use high grade materials for all coolers and condensers, thus ensuring a remarkably long life. Helpman can therefore offer a full two year guarantee on all equipment.

Fans and Fan Motors

Fans with aluminium fan blades, fitted with robust epoxy coated fan guards in anti-vibration mountings. Enclosed design fan motors, protection class IP55. All motors with terminal box with 2 cable inlets Pg 13.5. Motors are equipped with a thermal safety device built in the windings, connected to separate terminals in the box. This safety device can therefore be integrated into the control circuit.

The electrical control should be arranged preferably with a manual reset device in order to prevent continuous on/off switching (tripping) of the motors.

The single phase (220/1) motors are suitable for 220-240 V, 50 Hz, 1 phase supply.

The three phase (380/3) motors are suitable for 220-240 / 380-415 V, 50 Hz, 3 phase supply. 60 Hz models on request.

Defrost

Heavy Duty Electric Defrost

Stainless steel heater elements placed in additional tubes between the evaporator tubes. The elements for the driptray are fitted to the bottom of the innertray. Both coil and driptray have the same elements. Voltage : 220-240/1.

Coolers equipped with 3 or multiple of 3 elements are suitable for 220-240/1, 220-240/3 or 380-415/3 supply when connected either in delta or star.

All elements can be withdrawn at the refrigerant connection side. The driptray elements can be taken out after removal of the outertray.

Heater elements are connected to a terminal box. Electric defrost is indicated with **E**, e.g. **LEX 24 - 7 E**.

For reduced defrosting power (75 %, 6 or multiple of 6 elements only) see below.

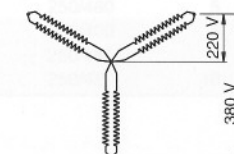

Standard

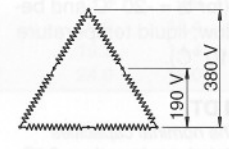

Reduced defrost
 (re-wiring of heaters to be done in terminal box).

Hot-gas defrost

Copper coil fitted to the bottom of the innertray. This execution is indicated as **G**, e.g. **LEX 24 - 7 G**.

Corrosion protection

For application in aggressive cooling environments coolers are available with a fully coated coil block (by submersion).

This execution is indicated as **C**, e.g. **LEX 24 - 7 C**.

Note ! Execution C is not possible for LEX 30 and generally not in combination with electric defrost E.

Fins of prepainted aluminium (Goldlack) on request.

Blow Through Unit Coolers

1.5 - 40 kW

LEX

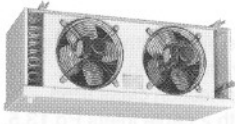

Nominal Capacities (kW)

Cooler type	R 22 frosted DT ₁	R 134a frosted DT ₁	R 404A frosted DT ₁	For reference only dry conditions DT ₁		
				R 22	R 134a	R 404A
Fin spacing 4 mm						
LEX 2-4	1.5	1.3	1.5	1.3	1.1	1.3
LEX 4-4	1.9	1.5	1.8	1.7	1.3	1.6
LEX 6-4	2.8	2.4	2.8	2.4	2.1	2.5
LEX 8-4	4.7	4.1	4.7	4.1	3.5	4.1
LEX 10-4	4.7	4.4	4.8	4.1	3.8	4.2
LEX 12-4	5.9	5.6	6.2	5.1	4.9	5.4
LEX 14-4	6.5	6.4	7.1	5.7	5.6	6.2
LEX 16-4	8.7	8.4	9.3	7.5	7.3	8.1
LEX 18-4	9.7	8.7	9.8	8.5	7.6	8.6
LEX 20-4	12.8	10.8	12.7	11.2	9.4	11.0
LEX 22-4	16.1	13.0	15.4	14.0	11.3	13.4
LEX 24-4	20.0	16.1	19.2	17.4	14.0	16.7
LEX 26-4	26.0	23.0	26.0	22.6	20.0	22.6
LEX 28-4	32.8	29.0	33.2	28.5	25.2	28.9
LEX 30-4	40.3	32.5	38.5	35.0	28.3	33.4

Fin spacing 7 mm						
LEX 2-7	1.3	1.2	1.3	1.1	1.0	1.2
LEX 4-7	1.7	1.4	1.7	1.5	1.2	1.4
LEX 6-7	2.5	2.2	2.5	2.2	1.9	2.2
LEX 8-7	4.1	3.7	4.3	3.6	3.3	3.7
LEX 10-7	3.7	3.6	4.0	3.2	3.2	3.5
LEX 12-7	5.0	4.9	5.3	4.4	4.3	4.6
LEX 14-7	5.5	5.5	6.0	4.8	4.8	5.2
LEX 16-7	7.4	7.3	8.0	6.4	6.3	7.0
LEX 18-7	8.5	7.8	8.8	7.4	6.8	7.6
LEX 20-7	11.4	10.0	11.4	9.9	8.7	9.9
LEX 22-7	14.5	12.4	14.3	12.6	10.7	12.4
LEX 24-7	18.1	15.6	17.8	15.7	13.5	15.5
LEX 26-7	22.8	21.2	23.4	19.8	18.4	20.4
LEX 28-7	28.5	26.5	29.3	24.8	23.0	25.5
LEX 30-7	36.5	31.0	35.9	31.7	27.0	31.2

Capacities

Frosted Conditions

- Lightly frosted coil.
- Relative humidity 85 %
- Suction gas superheating 62 % of the temperature difference (DT₁), with a minimum of 3.5 K
- Refrigerant liquid temperature 30 °C (for t₀ = -20 °C and below; liquid temperature 10 °C).

DT₁

The nominal capacities stated, are based on -8 °C evaporating temperature (t₀) and 8 K difference between air-on and evaporating temperature. (ENV 328, Condition II)

t₀

Evaporating temperature t₀ is the saturated temperature according to the pressure at the suction outlet of the cooler.

Dry Conditions

Cooling capacity where no condensation or ice build-up occurs on the coil (100% sensible cooling). This condition is used by Cecomaf to standardise capacity ratings but should not be used when selecting coolers.

Correction Factors R 404A / DT₁

DT ₁ K	Evaporating Temperature (t ₀) °C									
	+5	0	-5	-8	-10	-15	-20	-25	-30	-35
6	1.22	1.32	1.41	1.48	1.54	1.60	1.65	1.70	1.77	
7	1.01	1.09	1.17	1.24	1.30	1.36	1.41	1.47	1.54	
8	0.85	0.92	0.97	1.00	1.03	1.12	1.18	1.23	1.29	1.37
9	0.73	0.80	0.86	0.92	0.98	1.03	1.09	1.16	1.24	
10	0.64	0.70	0.75	0.81	0.87	0.92	0.98	1.05	1.13	
11	0.56	0.61	0.67	0.72	0.77	0.83	0.89	0.96	1.05	

Correction Factors R 22 / DT₁

DT ₁ K	Evaporating Temperature (t ₀) °C									
	+5	0	-5	-8	-10	-15	-20	-25	-30	-35
6	1.10	1.20	1.31	1.42	1.53	1.62	1.66			
7	0.93	1.01	1.11	1.22	1.32	1.40	1.46			
8	0.80	0.88	0.95	1.00	1.05	1.16	1.24	1.30		
9	0.70	0.77	0.85	0.94	1.03	1.12	1.18			
10	0.61	0.68	0.76	0.84	0.93	1.02	1.09			
11	0.55	0.61	0.68	0.76	0.85	0.94	1.01			

Correction Factors R 134a / DT₁

DT ₁ K	Evaporating Temperature (t ₀) °C									
	+5	0	-5	-8	-10	-15	-20	-25	-30	-35
6	1.10	1.23	1.35	1.44	1.52	1.57	1.63	1.69	1.79	
7	0.93	1.05	1.15	1.23	1.30	1.36	1.41	1.48	1.57	
8	0.81	0.90	0.97	1.00	1.05	1.14	1.19	1.25	1.31	1.41
9	0.71	0.80	0.88	0.95	1.01	1.07	1.12	1.19	1.28	
10	0.63	0.71	0.78	0.85	0.91	0.97	1.02	1.09	1.18	
11	0.56	0.64	0.71	0.77	0.83	0.88	0.94	1.01	1.10	

Blow Through Unit Coolers 1.5 - 40 kW

LEX

Dimensions / Connections

Cooler type	Dimensions mm							Shipp. vol. m ³	Cooler weight		Coil surface		Int. vol. dm ³	Refrig. conn.	
	A	B	D	F	G	H	K		4 mm kg	7 mm kg	4 mm m ²	7 mm m ²		inlet O.D.	suction O.D.S.
LEX 2 - •	598	412	465	365	-	360	380	0.3	18	17	7.7	4.7	2.1	1/2"	1/2"
LEX 4 - •	658	472	495	395	-	430	440	0.3	22	21	11.2	6.7	3.0	1/2"	1/2"
LEX 6 - •	658	472	605	503	-	430	440	0.3	27	25	16.8	10.1	4.0	1/2"	5/8"
LEX 8 - •	788	602	640	503	-	505	570	0.6	38	35	26.1	15.7	6.0	1/2"	22 mm
LEX 10 - •	1106	920	495	395	-	430	880	0.5	35	32	22.4	13.5	6.0	1/2"	22 mm
LEX 12 - •	1106	920	605	503	-	430	880	0.5	42	38	33.6	20.2	6.8	1/2"	28 mm
LEX 14 - •	970	692	710	520	35	600	660	0.6	50	46	35.2	21.2	8.0	1/2"	28 mm
LEX 16 - •	1110	792	750	520	35	675	760	0.7	65	61	46.4	27.9	10.4	1/2"	28 mm
LEX 18 - •	1460	1180	690	500	35	520	1140	1.0	71	65	52.2	31.4	11.6	1/2"	35 mm
LEX 20 - •	1640	1360	710	520	35	600	1320	1.3	95	88	70.5	42.4	15.5	5/8"	35 mm
LEX 22 - •	1880	1560	750	520	35	675	1520	1.7	120	111	92.8	55.9	20.4	5/8"	42 mm
LEX 24 - •	1880	1560	950	630	110	825	1520	2.2	139	128	116.0	69.8	28.2	5/8"	42 mm
LEX 26 - •	2650	2328	750	520	35	675	2290	2.3	172	159	139.8	84.2	30.9	5/8"	54 mm
LEX 28 - •	2650	2328	920	630	110	825	2290	3.0	202	186	174.7	105.2	39.8	5/8"	54 mm
LEX 30 - • ¹	3420	3098	920	630	110	825	3050	3.9	278	256	232.7	140.1	51.1	5/8"	54 mm

LEX

Fans / Electric Defrost

Cooler type	Fans 50 Hz							Electric defrost					
	number	dia-meter mm	air volume fin spacing		air ² throw m	sound ³ level dB(A)	fan power nominal / absorbed ⁴		number of elements		defrost power ⁵		
			4 mm m ³ /h	7 mm m ³ /h			220/1 W	380/3 W	coil	driptray	kW	reduced kW	
LEX 2 - •	1	254	1030	1080	10	48	30/80	30/65	1	1	1.28	-	
LEX 4 - •	1	305	1490	1570	12	50	30/100	30/100	1	1	1.76	-	
LEX 6 - •	1	305	1420	1500	12	50	30/100	30/100	2	1	2.64	-	
LEX 8 - •	1	356	2490	2620	15	53	70/160	90/145	2	1	3.0	-	
LEX 10 - •	2	305	2970	3130	15	53	30/100	30/100	1	1	3.2	-	
LEX 12 - •	2	305	2860	3010	15	53	30/100	30/100	2	1	4.8	-	
LEX 14 - •	1	406	3360	3540	15	57	70/230	90/215	5	1	4.5	3.4	
LEX 16 - •	1	457	4430	4660	20	60	220/380	250/400	5	1	6.0	4.5	
LEX 18 - •	2	356	4980	5240	20	56	70/160	90/145	2	1	5.4	-	
LEX 20 - •	2	406	6730	7080	20	60	70/230	90/215	5	1	8.4	6.3	
LEX 22 - •	2	457	8850	9320	20	63	220/380	250/400	5	1	13.2	9.9	
LEX 24 - •	2	508	11000	11600	20	66	220/430	250/480	5	1	13.2	9.9	
LEX 26 - •	3	457	13000	14000	20	65	220/380	250/400	5	1	19.2	14.4	
LEX 28 - •	3	508	16600	17500	20	68	220/430	250/480	5	1	19.2	14.4	
LEX 30 - •	4	508	22200	23400	20	69	220/430	250/480	10	2	24.0	18.0	

1) LEX 30 :
3 mounting channels, dist. 1/2 B = 1549 mm
2 water drains, 1" BSP male, distance 1700 mm

2) Air throw at t = 20 °C.
Minimum air velocity = 0.25 m/s.

3) Sound levels are the results of tests carried out in free field conditions. The values are measured in the horizontal plane at a distance of 5 meter with an A-filter. Values may deviate depending on situations at site.

4) Fan power is given per motor. Absorbed fan power is measured with coil face area blocked for 75 % and ambient temperature 20 °C.

5) Total defrost power is based on 220 V.
For 240 V this value increases by 20 %.

LEX 2 - 12

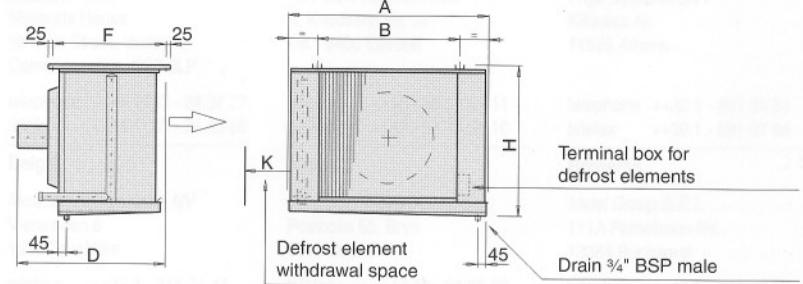

LEX 14 - 30

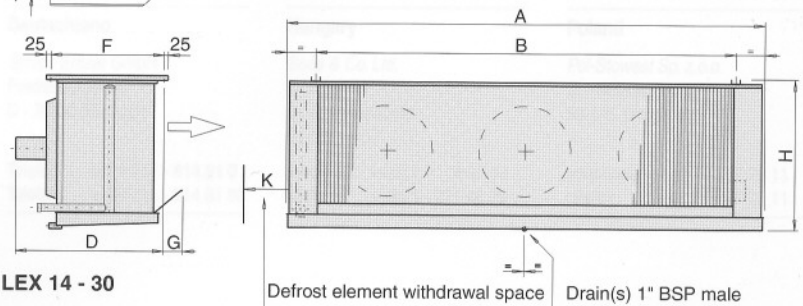

Blow Through Unit Coolers 1.5 - 40 kW

LEX



Overload Relays

For installations equipped with motor switches with thermal overload relays the following points are essential :
 In the fan data tables the motor power as given on the name plate of the motor is listed.
 As the fan motor on a cooler is intensively cooled by the air flow it is possible to load the motor over its nominal power. The maximum allowable Amps are given on the motor name plate.
 In the table below the overload relay settings are listed for various ambient temperatures.
 These values are valid for a frosted coil with the face area blocked for 75 %.

Adjustment values for overload relays (50 Hz, nom. 1500 rpm)

t °C	220-240/50/1					
	30 W		70 W		220 W	
	220 V	240 V	220 V	240 V	220 V	240 V
0	0.49	0.51	1.22	1.20	2.54	2.64
-20	0.51	0.53	1.27	1.24	2.73	2.81
-40	0.54	0.55	1.35	1.35	2.82	2.88

t °C	220-240/380-415/50/3				
	30 W				
	220 V	Δ	240 V	380 V	Y
0	0.42	0.46		0.24	0.26
-20	0.45	0.48		0.26	0.28
-40	0.47	0.49		0.27	0.29

t °C	90 W				
	220 V	Δ	240 V	380 V	Y
	0	0.86	0.88		0.50
-20	0.90	0.92		0.52	0.53
-40	0.95	0.97		0.55	0.56

t °C	250 W				
	220 V	Δ	240 V	380 V	Y
	0	1.87	1.87		1.08
-20	1.98	1.91		1.14	1.10
-40	2.13	1.94		1.23	1.12

Optional Features

■ Klixon Switch

The Klixon switch is used for coolers fitted with electric defrost to reduce the defrost time. This gives higher defrost efficiency and saves running costs.
 The switch opens at +12 °C (± 3 K) and terminates the defrost period. In the cooling cycle the switch closes at -5 °C (± 3 K). The Klixon-switch can only be used when room temperature is below -10 °C. Switch capacity is 5 A at 240 V (non inductive), cable length 500 mm.

■ Supports for Wall Mounting

Supports for wall mounting are delivered in sets comprising 2 or 3 supports with associated 4 or 6 special bolts, nuts and washers for mounting the cooler to the supports. Type B 30 is for mounting the vertical leg behind the insulation.

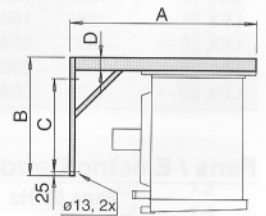

Type	Cooler model	Dimensions mm			
		A	B	C	D
B 10	LEX 2, 4 and 10	603	504	355	30
B 20	LEX 2 - LEX 22	853	704	500	75
B 30	LEX 2 - LEX 30 *	1103	704	500	75

* For LEX 30 a set of 3 supports is required.

■ Fan ring heater

When air coolers are to operate under humid working conditions, fan ring heaters can be used to prevent fans from jamming by ice or frost build up. Fan ring heaters are available for all models with fans ø 406, 457 or 508 mm.

■ Hinged driptray

For all models a hinged driptray construction for easy access and cleaning purposes is optional.

■ Water Drain Connections

Brass elbow,
 2 x ¼" BSP female.
 Article no.: 26 26 18



■ Re-heating Elements XR / HR

At low ambient temperatures the humidity in the cold room may become too high due to a short running time of the compressor.
 With the use of an electric heater in association with the fans running, the room temperature rises and the compressor will start. Under these conditions the humidity of the air in the room can be reduced.

Re-heating elements are available in two executions:
 - Finned Tube Heating Elements (XR)
 - Smooth Tube Heating Elements (HR)



Eflo Refrigerant Circuiting

The optimal use of the available heat exchanging surface by means of "EFLO" liquid distribution system is based on two principles :

- The refrigerant is evaporating through the coil in parallel flow with the air.
- Superheating takes place on the air-inlet side, in the area with the highest tube temperature.

With EFLO, the cooling performance improves as a result of :

- Even frost formation over the coil.
- Prolongued cooling cycle, therefore a higher effective cooling capacity.
- Shorter defrost cycle.

- 1: Refrigerant inlet temperature.
- 2: Beginning of superheating refrigerant vapour.
- 3: Evaporating temperature (to) corresponding with the pressure at the outlet of the cooler.
- 4: Superheating temperature.
- 5: Air-inlet temperature.
- 6: Air-outlet temperature.

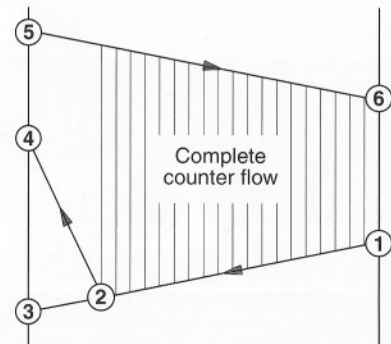
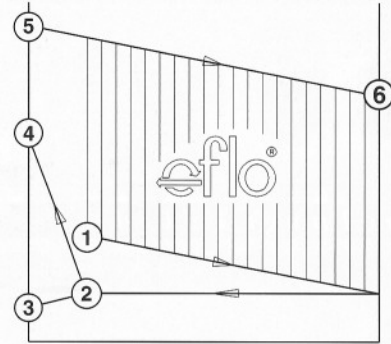

Factory and Head Office

Apparatenfabriek Helpman BV
Postbus 44
NL 9700 AA Groningen
Peizerweg 97

telefoon ++31 50 - 521 75 55
telefax ++31 50 - 526 48 78
E-mail info@helpman.nl
internet www.helpman.nl

Bulgaria

Helpman Sofia EOOD
89, Tzar Boris III Bld.
1612 Sofia

telefoon ++359 2 - 581 52 98
telefax ++359 2 - 581 52 98

United Kingdom

APS Ltd.
Meliorate House
98 Main Street, Yaxley
Cambridgeshire, PE7 3LP

telefoon ++44 1733 - 24 37 77
telefax ++44 1733 - 24 38 88

België

Molimex-Refrigeration NV
Vierwinden 6
1930 Zaventem

telefoon ++32 2 - 715 24 44
telefax ++32 2 - 725 22 26

Deutschland

Schick Emzet GmbH
Postfach 301049
D - 70450 Stuttgart

Telefon ++49 711 - 814 91 0
Telefax ++49 711 - 814 91 30

Ireland

HRP Wholesale.
100 Slaney Road,
Dublin, Ind. Estate,
Finglas, Dublin 11

telefoon ++353 1 - 830 65 65
telefax ++353 1 - 830 61 53

Danmark

AIR-CON Danmark A/S
A. Knudsens Vej 15
DK - 8400 Ebeltoft

telefoon ++45 - 86 34 51 11
telefax ++45 - 86 34 58 10

Norge

Schlösser Møller Kulde A/S
Postboks 65, Bryn
0611 Oslo-6

telefoon ++47 22 - 64 65 60
telefax ++47 22 - 64 65 77

Hungary

Soós & Co. Ltd.
P.O. Box 94
H-1631 Budapest
Cziráki út 5-7

telefoon ++36 1 - 114 97 93
telefax ++36 1 - 221 46 79

Turkey

Sogusan Ltd. Sti.
Necatibey Cad. Gayret Han 69
209 - 11 Karaköy
Istanbul

telefoon ++90 1 - 293 76 48
telefax ++90 1 - 293 71 10

Greece

Frigo Systems SA
Kifissias Av.
11525 Athens

telefoon ++30 1 - 691 04 54
telefax ++30 1 - 691 07 64

Romania

Midal Group S.R.L.
111A Pantelimon Rd.
73384 Bucharest

telefoon ++40 1 - 312 35 03
telefax ++40 1 - 312 31 05

Poland

Pol-Stowest Sp. z.o.o.
Ul. Klimasa 46
50-515 Wroclaw

telefoon ++48 71 - 67 75 11
telefax ++48 71 - 67 75 11